

# Edyta Klimaszewska-Drabot

---

## Early Makuria Research Project : The Pottery

---

Polish Archaeology in the Mediterranean 18, 477-491

---

2008

Artykuł został opracowany do udostępnienia w internecie przez Muzeum Historii Polski w ramach prac podejmowanych na rzecz zapewnienia otwartego, powszechnego i trwałego dostępu do polskiego dorobku naukowego i kulturalnego. Artykuł jest umieszczony w kolekcji cyfrowej [bazhum.muzhp.pl](http://bazhum.muzhp.pl), gromadzącej zawartość polskich czasopism humanistycznych i społecznych.

Tekst jest udostępniony do wykorzystania w ramach dozwolonego użytku.

# EARLY MAKURIA RESEARCH PROJECT: THE POTTERY

Edyta Klimaszewska-Drabot

The present report concerns the pottery assemblage collected during the second season of the Early Makuria Research Project (MtoM), which took place in January-February 2006 (see above, report by W. Godlewski in this volume).<sup>1</sup> The work was carried out in the fort of Merowe Sheriq

and at the cemetery in Tanqasi, contributing new data on these little known sites. Like el-Zuma investigated in the previous season (El-Tayeb 2005), the sites now investigated promise to provide important information on the formative stages of the kingdom of Makuria.

## POTTERY FROM MEROWE SHERIQ

Four sites were identified at the fort of Merowe Sheriq and in the neighborhood: the fort Msh.1, neighboring settlement Msh.2, well Msh.3 and Christian burial ground Msh.4 (see above, report by W Godlewski in this volume). Most of the pottery was collected from the surface inside

the fort (215 sherds) and in the settlement (188 sherds); 131 sherds were recovered from a test pit dug inside the fort. The pottery from the burial ground was collected on the surface and from one disturbed tomb, hence it is treated as a single secondary context. Finally,

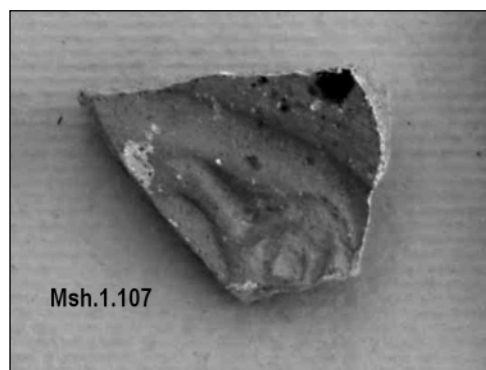
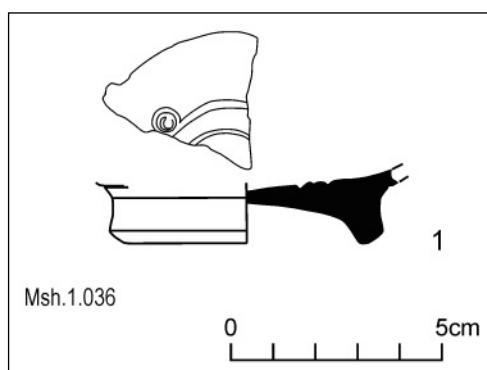

Fig. 1. Sherds with stamped decoration from Merowe Sheriq  
(Photo W. Godlewski)

1 Original drawings by A. Błaszczuk, E. Klimaszewska-Drabot, B. Wojciechowski; digitized by E. Klimaszewska-Drabot.

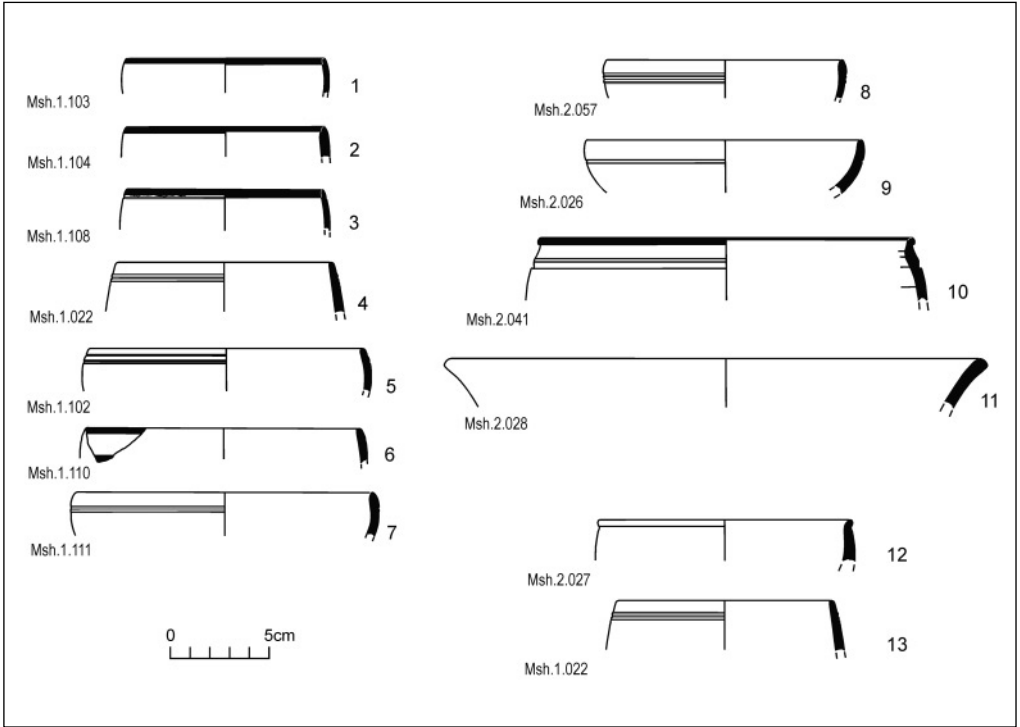

Fig. 2. Red (1-11) and white (12-13) tableware cups and beakers from Merowe Sheriq

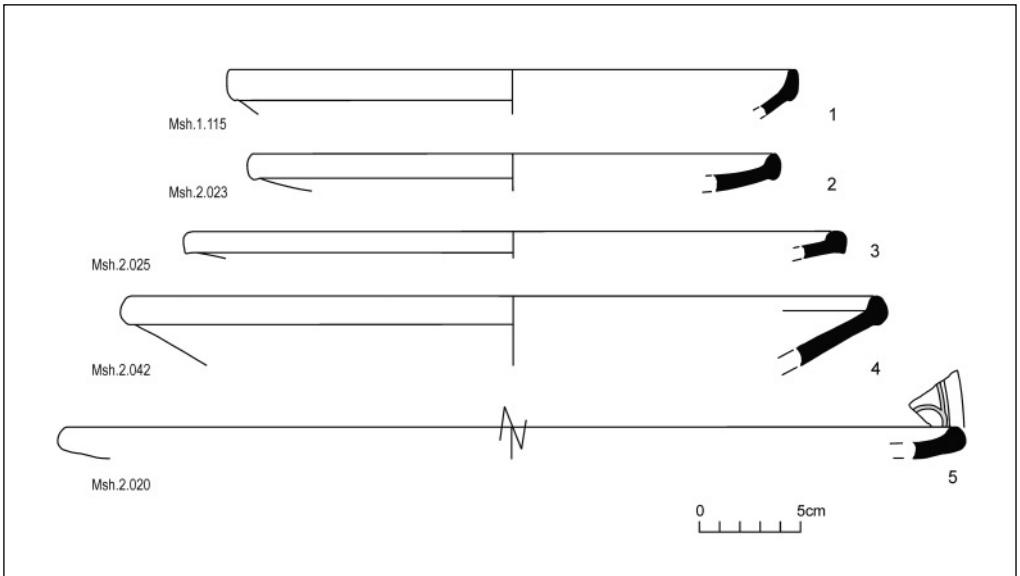

Fig. 3. Plates from Merowe Sheriq

22 pieces of pottery were gathered from the surface of the well, which was filled already in Christian times and which stood inside the border of the settlement.

Most of the sherds are fragmentary and difficult to date, but even so, the assemblage deserves to be presented for it leads to conclusions concerning the functioning of the fort and the nearby sites.

#### WHEEL-MADE VESSELS

A numerous category from both the fort and settlement was the tableware. These high-quality, thin-walled wheel-made vessels are all attributable to the 6th century.

The thin-walled cups and bowls are red-slipped on the outside and inside [Fig. 2:1-11], more rarely white-slipped [Fig. 2:12-13], and polished. The decoration consists of dark brown lines under the rim and sometimes on the body, or else horizontal relief lines executed prior to firing.

Plates are also red-slipped and polished, mostly without decoration [Fig. 3]; one piece [Fig. 3:5] has a white-painted ornament around the rim. Despite the fragmentariness of this collection, parallels

are easily found in the ceramic material from Old Dongola (Godlewski 1991: 11-114, 117, Figs 5, 8; Pluskota 1991: 41-45) and the Fourth Cataract (Pluskota 2005b: 125-126, Figs 1,5).

Two fragments of vessel bases bear stamped decoration, unfortunately fragmentarily preserved [Fig. 1]. Some fragments are painted with a geometric ornament [Fig. 4].

Amphorae constitute a numerous group. These are mainly small sherds from the body, handles and neck, belonging to different types and including imports. Two early examples merit attention [Fig. 5:1, 2], as well as a neck and handle [Fig. 5, right]

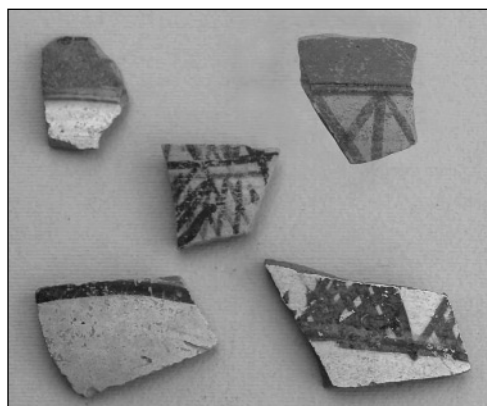

Fig. 4. Surface finds of painted sherds from the fort at Merowe Sheriq (Photo W. Godlewski)

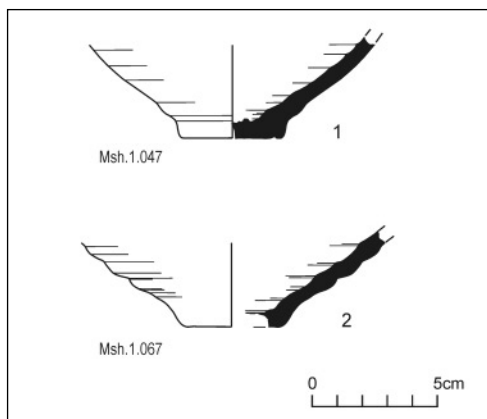
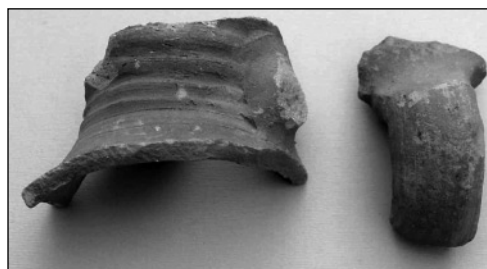

Fig. 5. Amphorae from Merowe Sheriq (sherds Msh.1.018 and Msh.1.026 in photo) (Photo W. Godlewski)



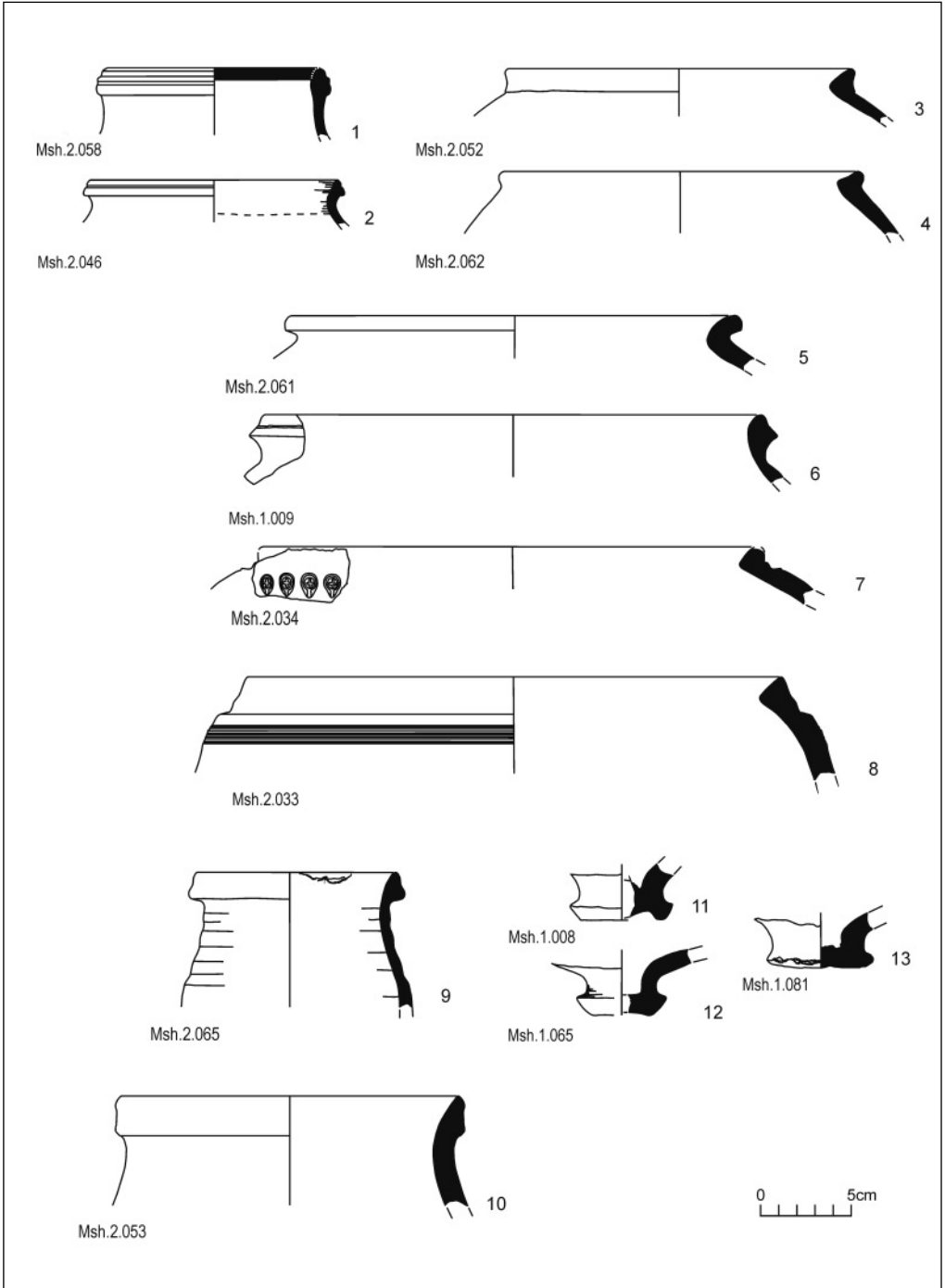

Fig. 6. Wheel-made storage vessels from Merowe Sheriq

belonging to popular 6th century products of Dongolan workshops (Godlewski 1991: P. 118; Pluskota 2005b: P. 230, Fig. 8).

Storage vessels and jars of different shape [Fig. 6] were more numerous at the settlement. From an early period come the rims of jars and other storage vessels, red-slipped on the outside and sometimes also on the inside, but only around the rim. One piece has a brown-painted band below the rim on the inside [Fig. 6:1]. Another bears a relief band of motifs with an incised sign of a cross [Fig. 6:7].

Few diagnostic sherds of Classic Christian vessels have been found and decorated pots are just as rare. One example is a bowl with everted rim decorated inside with a painted motif and the sign of a cross engraved already after firing. Another example is a yellow-slipped rim with a guilloche on the inside (Adams 1986: vol. I, 245 – style N.IV.A) [Fig. 7].

#### HANDMADE VESSELS

Handmade vessels constitute a separate category. These are mainly utilitarian vessels

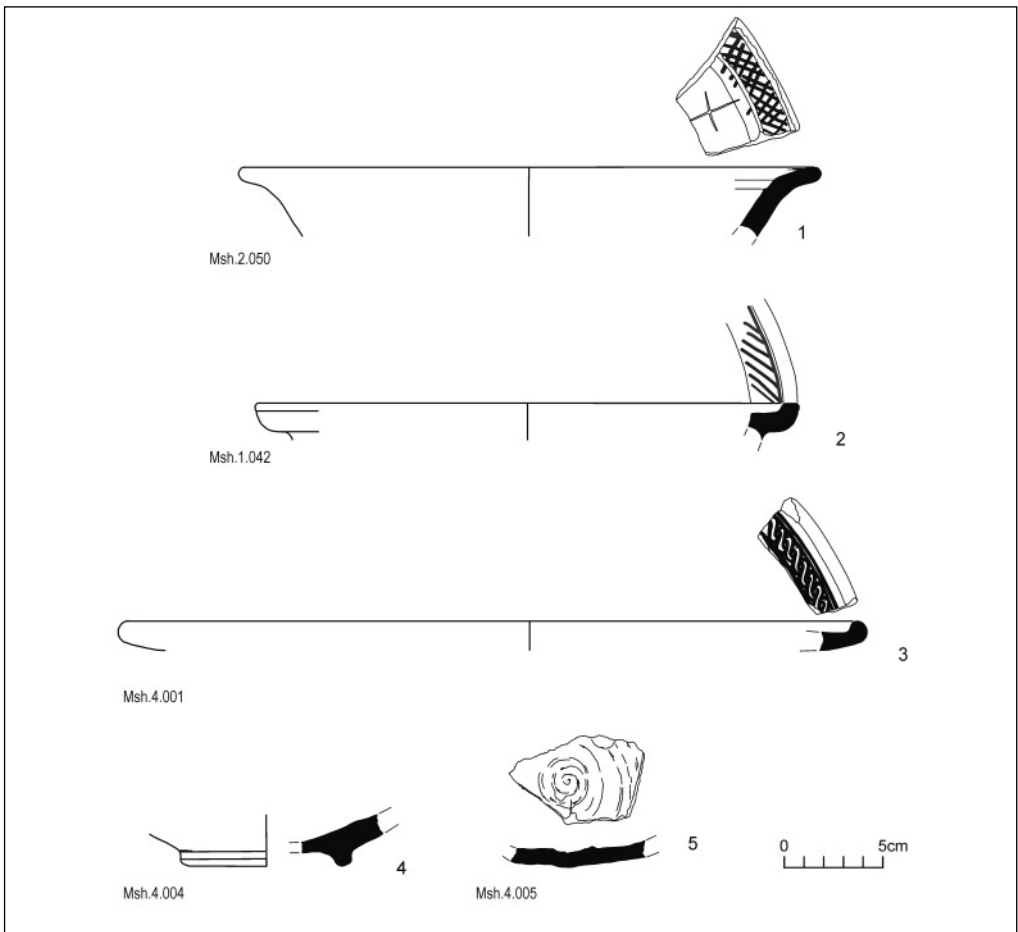

Fig. 7. Classic Christian vessels from Merowe Sheriq

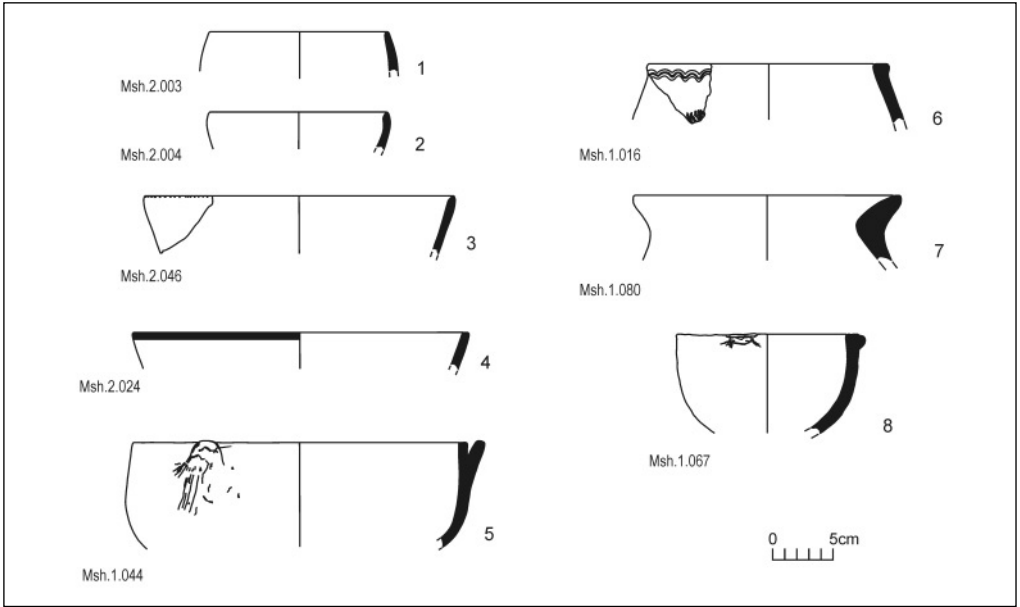

Fig. 8. Handmade vessels from Merowe Sberiq

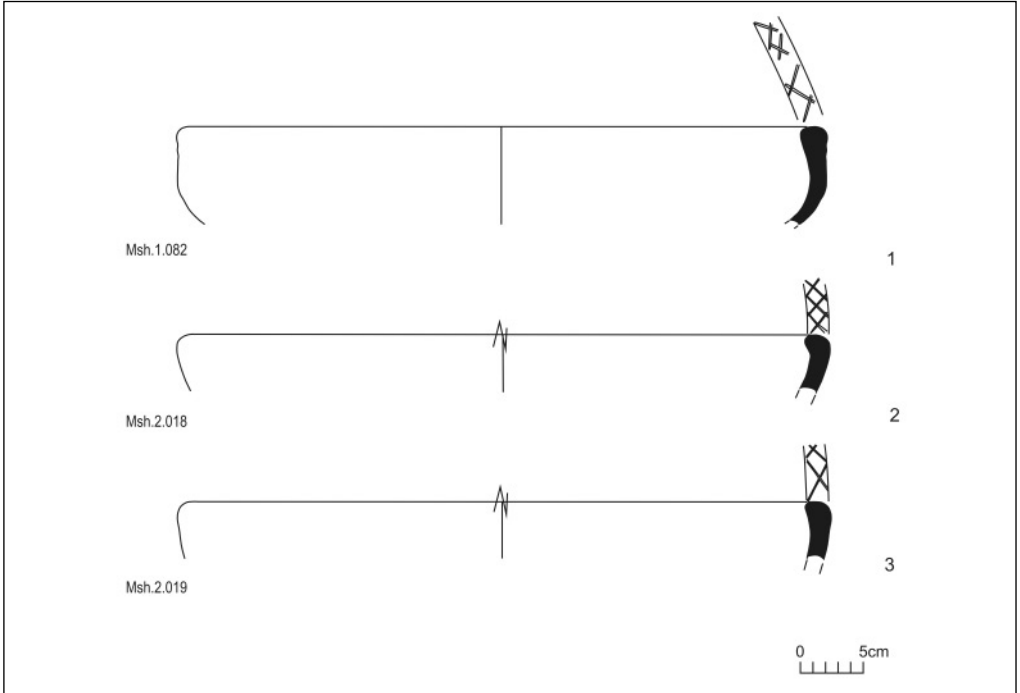

Fig. 9. Doki vessels from Merowe Sberiq

of rather poor quality, intended for kitchen use. Evidence of use is clear with many pots showing burning and soot as a result of frequent cooking. Better quality pots are imitations of wheel-made products. Dating of these vessels is difficult for lack of more detailed studies of handmade products from the Christian and Islamic periods.

Bowls [Fig. 8:1-4] frequently imitate wheel-made counterparts. The thin walls, red-slipped inside and outside, are often additionally burnished and decorated with painted bands near the rim or incised ornaments on it.

Cooking pots are very common, burned secondarily and with traces of soot, which indicate intensive use. These are most often pots with small lug handles [Fig. 8:5, 8] or *doki* at [Fig. 9], with incised decoration on the rims and a polished inside surface. Some pots have impressed ornaments on the outer surface. The bottoms have an additional layer of clay applied either with fingers or some tool on the outside. This feature is presumed to improve the vessel's heat-containing properties.

A few fragments of handmade domestic pots were found, decorated with stamped or engraved motifs, more seldom painted decoration.

## DISCUSSION

An analysis of the pottery material from the sites at Merowe Sheriq shows that the fort and settlement went back to the Transitional / Early Christian period and continued to exist through the end of this period. No occupational layers were identified in the test pit, the fill was very mixed and the pottery represented a very broad chronological horizon. There is much less material from the Classical period, as if the character of the settlement had changed. It surely existed, because the burial ground is most likely from this period. The later material is represented even more poorly, mainly cooking pots. The ruins of the fort may have been used for habitational purposes; a house was built there as late as the Shajqija times (see above, report by W. Godlewski in this volume).

While the pottery dates the fort to the Transitional / Early Christian period, the material used in its construction, as well as the existence of a well, testifies to longer occupation, reaching the Kushite period. In the entire collection there are only two sherds from a period earlier than Christian, but they are too fragmentary for more precise dating. Answers obviously lie in further excavations of the site.

## POTTERY FROM TANQASI

What little pottery material was picked up from the surface at Tanqasi consisted of mostly severely eroded nondiagnostic body sherds. The case was different with the tumulus Tnq.87 excavated by the mission, which yielded a disturbed but still interesting assemblage (for this work and a general introduction to the Tanqasi site,

see above, report by W. Godlewski in this volume). The tomb had been plundered in antiquity and more damage was done clandestinely during the present work. However, one of two chambers on the west side remained intact and in this case we are dealing with pottery vessels *in situ* (see Fig. 8 on p. 472).



The assemblage found in the various chambers of the tomb consisted of at least 27 vessels.<sup>2</sup> Most were found in the burial chamber on the south (cf. *Fig. 11* on p. 473) and in its vicinity, at the bottom of the shaft (perhaps taken out of the burial chamber during the original plundering), the rest in the chambers on the west (see *Figs 9 and 10* on p. 437), and north, intended for offerings alone. These vessels will be discussed first.

The various layers in the fill of the shaft yielded many sherds, but these were most likely not part of the grave goods; they were left by the builders or robbers, or were thrown in accidentally with the earth used to backfill the shaft. They will be discussed separately at the end of this section.

#### WHEELMADE VESSELS

The 17 bowls and cups which belong in the wheel-made category constitute a fairly homogeneous group made of a very similar, if not identical clay, characterized by fine-grained mineral temper and finely chopped chaff as organic temper. Physico-chemical analyses are underway to determine the composition of the clay and possible sources. Vessels are red-slipped on the outside and inside, and burnished. Wherever the burnishing was not very precise on the inside surface, traces of making on the wheel are in evidence as even quite thick coils of clay. No signs of use suggest that the vessels were made as tomb equipment, specifically for the purposes of this burial.

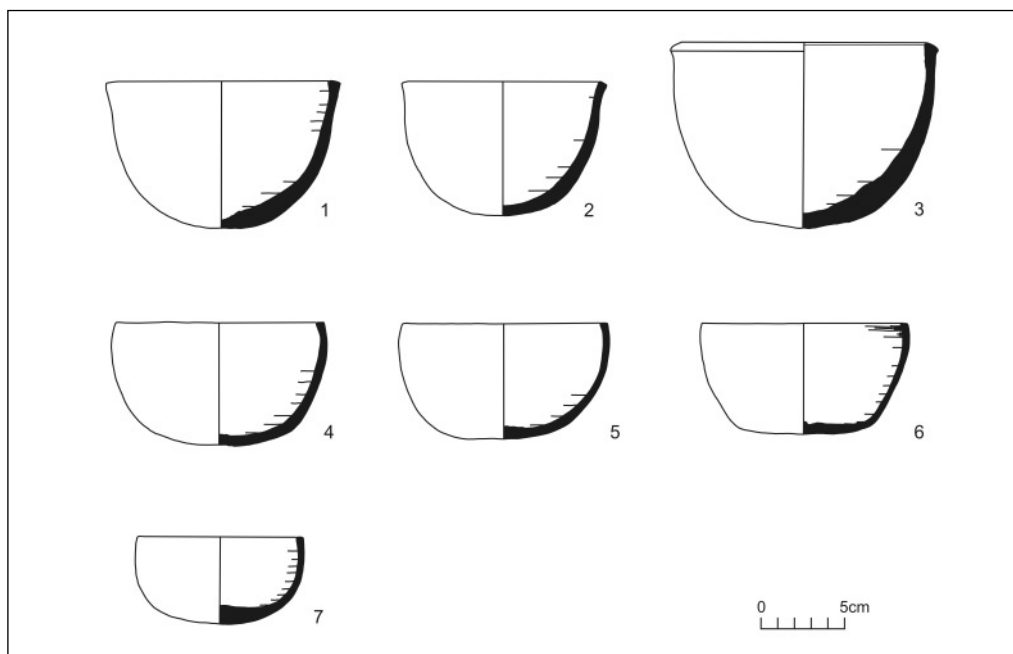

*Fig. 10. Wheel-made bowls: group 1 (1-3) and group 2 (4-7), from the burial chambers of tumulus tomb Tnq.87*

2 For a discussion of the importance of the pottery assemblage from the Tanqasi tumulus tomb Tnq.87, see my paper presented at the 11th Conference of Nubian Studies, held at the University of Warsaw in 2006 (Klimaszewska-Drabot, forthcoming).

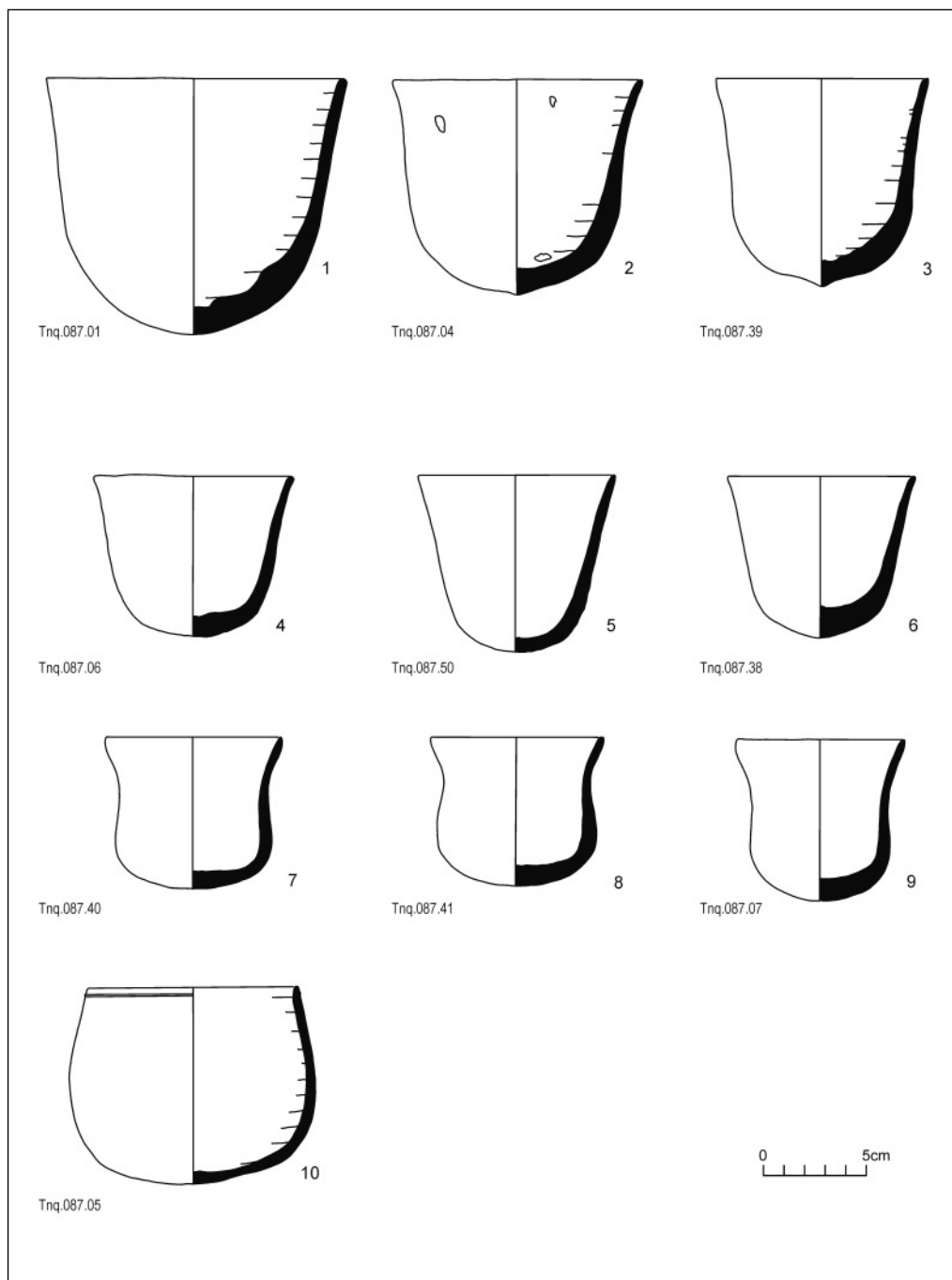

Fig. 11. Cups: group 1 (1-3), group 2 (4-9), group 3 (10), from the burial chambers of tumulus tomb Tnq.87

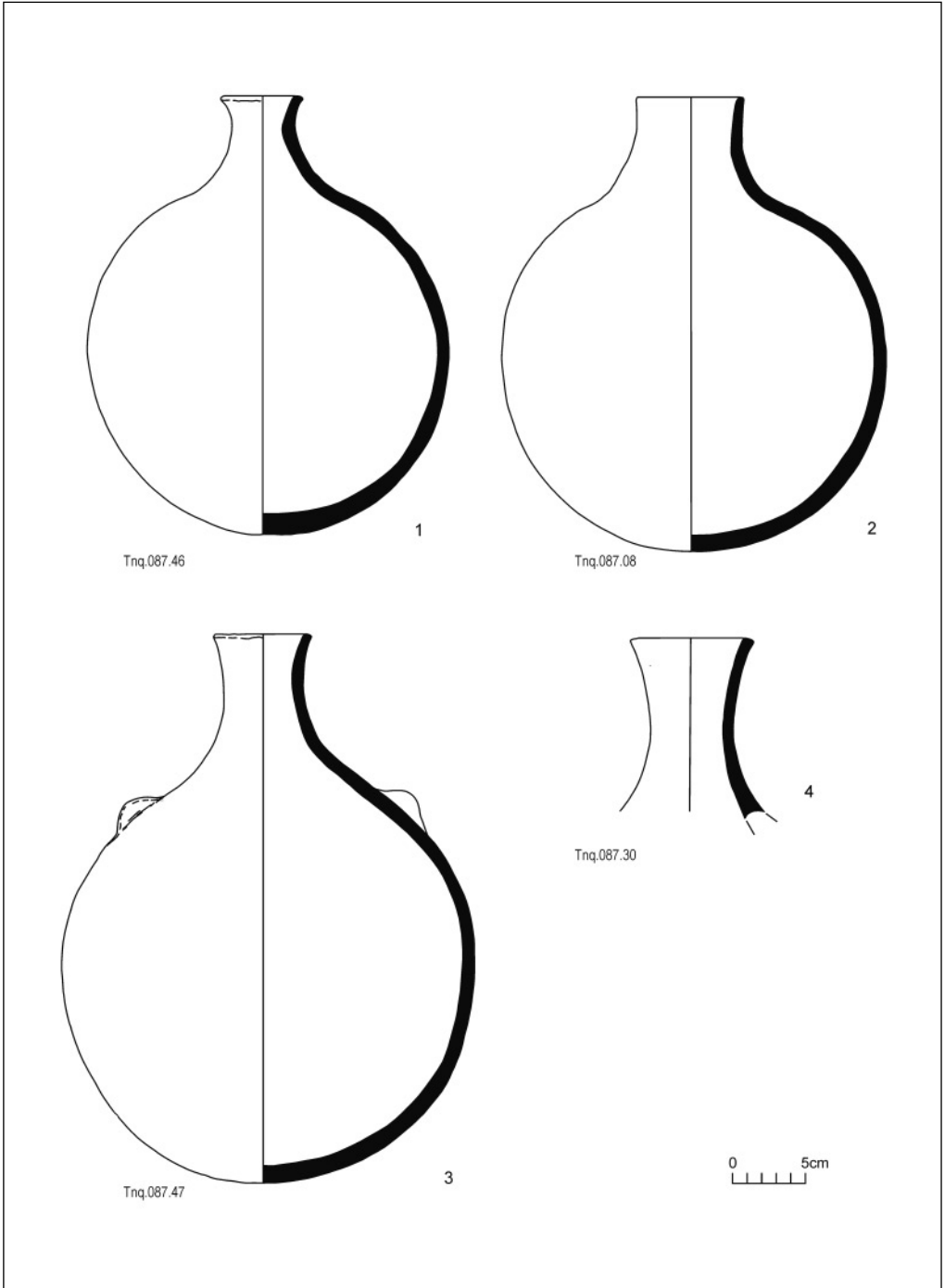

Fig. 12. Bottles ('beer jars') from the burial chambers of tumulus tomb Tnq.87

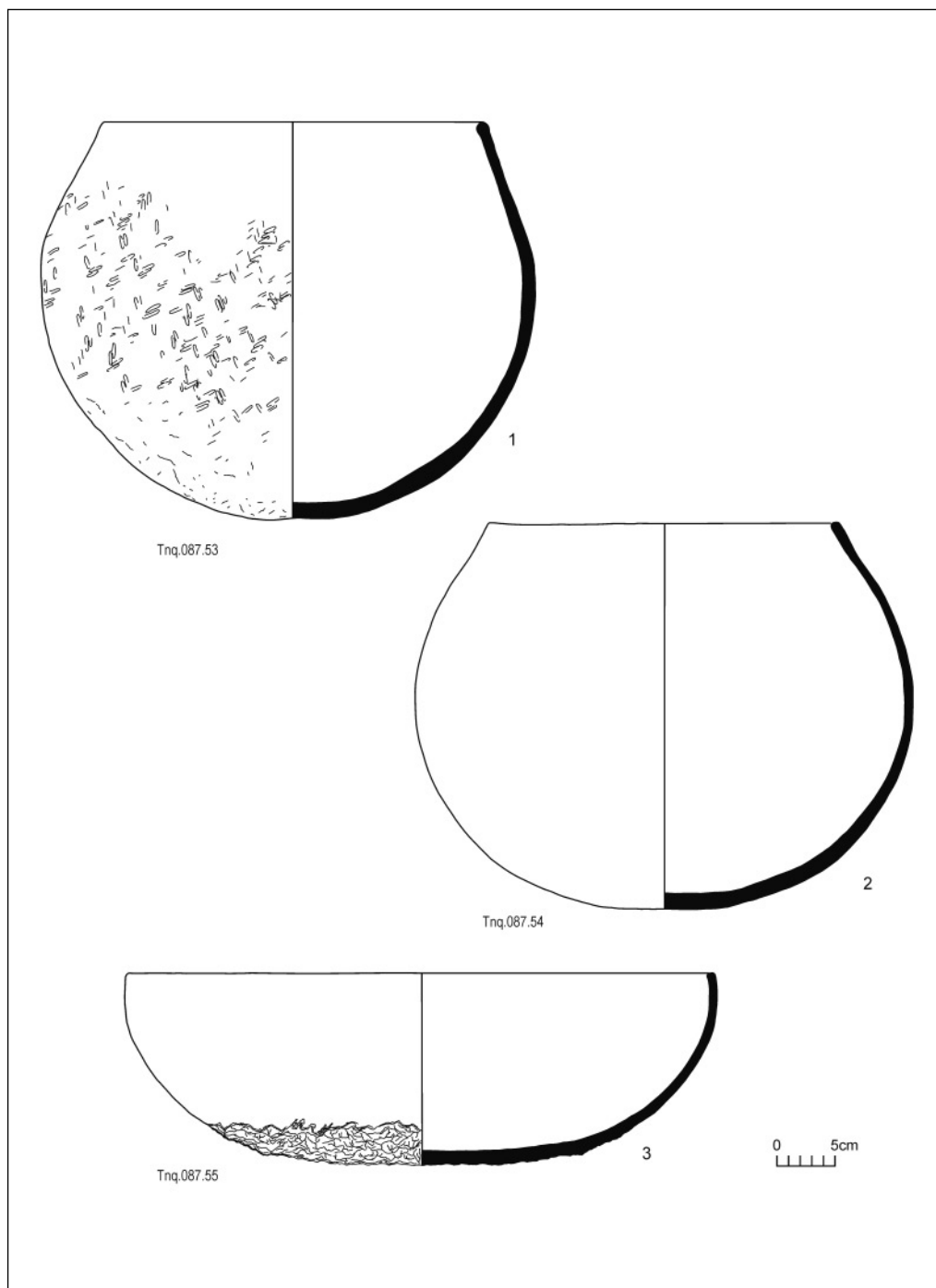

Fig. 13. Large cooking vessels from the burial chambers of tumulus tomb Tnq.87

Cups can be subdivided into three groups by shape and size: Group 1 comprising the bigger cups ranging between 10 and more than 12 cm in rim diameter, and from 10 to 14 cm high [Fig. 10:1-3], and Group 2 encompassing the smaller cups with a rim diameter between 7 and 9 cm, and 8-9 cm high [Fig. 10:4-9]. The shape in these two groups is more or less the same [Fig. 10:1-6]: rounded or slightly flattened base, sometimes deformed, quite thick; thin and slightly flaring rim. The smallest cups [Fig. 10:7-9] have rounded bases, but the recurved profile is different. One of the cups [Fig. 10:2] has a whitish substance splashed, apparently accidentally, over the outer and inner surface. Group 3 [Fig. 10:10] is represented by only one cup (rim diameter

10.2 cm, 9.6 cm high) characterized by a different shape: rounded base, sides tapering in, thin applied rim.

Bowls are represented by seven vessels, which can be classified in two separate groups: Group 1 [Fig. 11:1-3] – hemispherical bowls with rounded bases, straight walls and flattened, slightly everted rims; Group 2 [Fig. 11:4-7] – hemispherical bowls with more or less flattened bases, sometimes deformed, squared rims, slightly turned in. The bowls range between 10 and 15 cm in rim diameter and 5 and 11 cm in height.

Wheel-made vessels of these two classes are very typical of post-Meroitic cemeteries in the region between the third and fourth cataract. This is a local tradition beginning

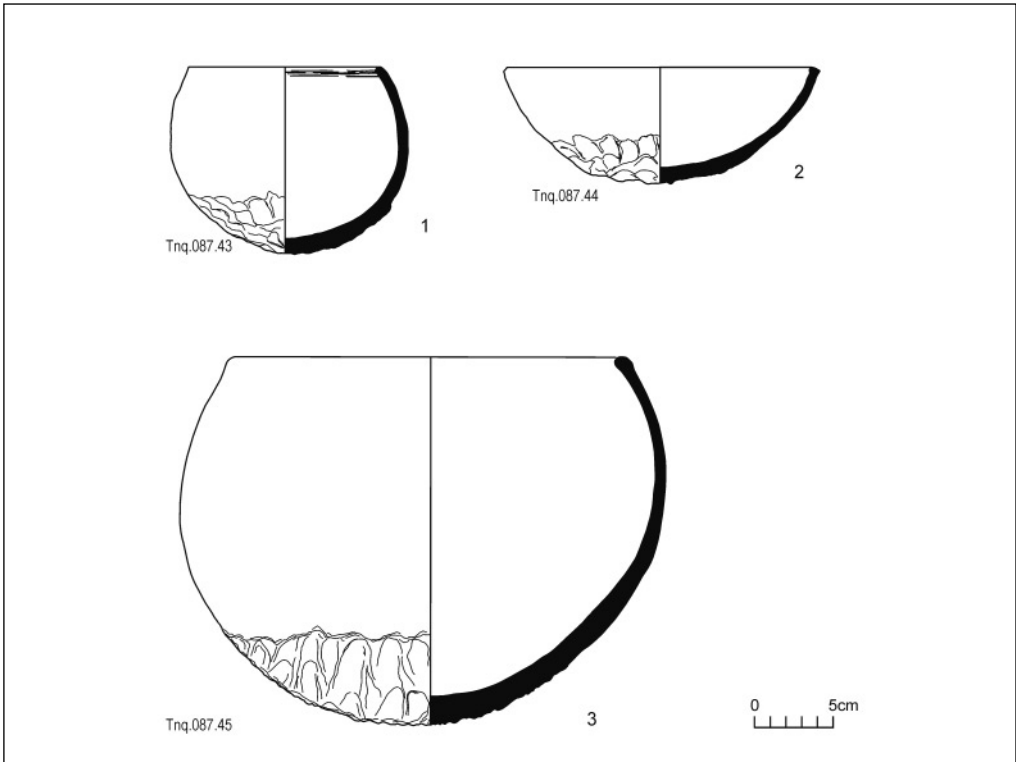

Fig. 14. Smaller variant of cooking vessels from the burial chambers of tumulus tomb Tnq.87

in the early 5th century and developing through the first half of the 6th century. Similar vessels are known from the cemeteries in Jebel Gaddar (El-Tayeb 1994), Hammur (Philips, El-Tayeb 2003), Kassinger Bahri (Kołosowska, El-Tayeb 2003: 122-125), Abu Haraz and el-Zuma (El-Tayeb 2005 and pers. comm.).

However, the tumulus excavated in Tanqasi yielded none of the very characteristic vessels with painted decoration, either bowls or cups, with one or more horizontal grooves under the rim or on the body, all of which are known from Jebel Gaddar (El-Tayeb 1994: Fig. 2, T1/i, T1/k),

Hammur (Philips, El-Tayeb 2003: with grooves – Pls 1, 2a, 4a-f, h, 8b, painted – Pl. 8a), Kassinger Bahri (Kołosowska, El-Tayeb 2003: with grooves – Fig. 5b,d,e, painted – Fig. 5d), Zuma (El-Tayeb 2005: Fig. 8 and pers. comm.).

#### HANDMADE VESSELS

Handmade pottery from the Tanqasi tomb includes nine complete or recombined bottles and cooking bowls, and one vessel preserved in fragments.

Bottles ('beer jars'), which had their beginnings in the Meroitic period and which were very popular in post-Meroitic

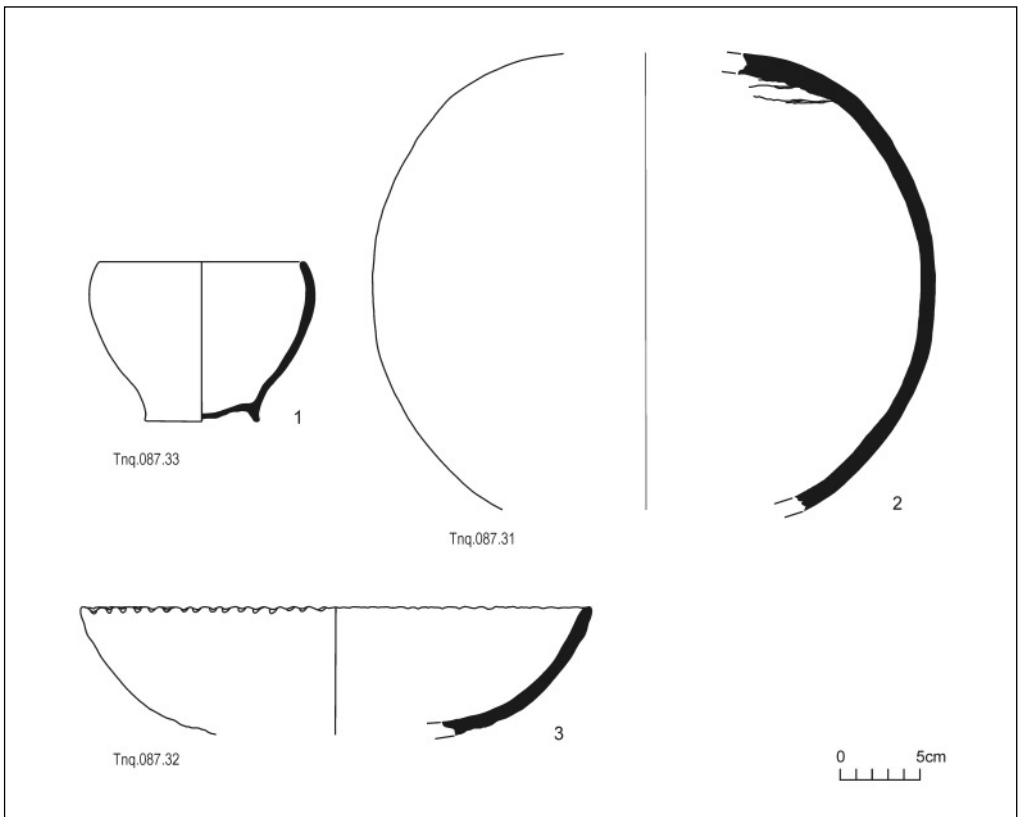

Fig. 15. Vessels from the fill of the shaft of tumulus tomb Tnq.87: goblet (1), bottle (2) and open bowl with stamped rim (3)

times albeit in slightly changed form, featured round or oval bodies, rounded bottoms and necks of various length, but relatively narrow compared to the body. The most common name for these vessels in publications, 'beer jars', is hardly justifiable as it has never been proved that they were used to store beer exclusively, if at all. They were used for storage and on a few rare occasions some organic material has been found inside bottles found in tomb contexts. It is hoped that there will be more emphasis placed on analysis of the contents of these bottles in the future.

The Tanqasi assemblage contains three complete [Fig. 12:1-3] and one fragmentary bottle [Fig. 12:4], all of a type typical in the region between the third and fourth cataracts (El-Tayeb 2002: 75). The average-sized bottle is of a height between 30 and 39 cm, well made, the outer surface slipped or well burnished, the neck medium-long, straight or slightly flaring in the direction of the rim. The biggest one [Fig. 12:3] has small lungs on opposite sides of opposite the shoulders and a red-slipped surface that has been burnished all over. Similar bottles are hardly common in post-Meroitic tombs and each is apparently a little bit different. A very similar piece but smaller was discovered in Jebel Kulgeili (Abdel Rahman, Kabashy 1999: Fig. 11.8).

Cooking vessels come in two variants. The smaller one [Fig. 14] is represented by three vessels: globular pot, shallow bowl and much bigger pot. All have clay roughly applied with the fingers on the base and lower part of the body, probably to disperse the heat of a fire more effectively through the body of the vessel. This type is rather frequent in post-Meroitic burials in this region (e.g. Philips, El-Tayeb 2003: Pl. 7). The bigger variant is a category unto itself,

more characteristic in territories lying further to the south and finding no parallels in the Dongola Reach [Fig. 13]. One bears a faint impression of matting on the body [Fig. 13:1], the other is plain [Fig. 13:2], both 33-34 cm in diameter and 34 cm in height. The third vessel is a flat bowl with extra clay applied on the bottom and finely polished walls inside [Fig. 13:3].

None of the cooking pots show any trace of use, the blackening seen on the surface being due to firing.

## VESSELS

### FROM THE FILL OF THE SHAFT

More than 70 sherds came from different layers of the fill found inside in the shaft. Most of these were severely damaged body fragments and a few had even been used for digging to judge by the worn and rounded breaks. Only two of the vessels were wheel-made, the rest were mostly thick-walled, handmade vessels, some with traces of impressed decoration, a few red-slipped, but mostly with very damaged surface.

Meriting attention in this group are three vessels, broken but still better preserved than others. One is a shallow open bowl with incised rim, found in the northern part of the shaft. It was strongly burned, even sooted as evidence of its heavy use [Fig. 15:3]. Another unique vessel is a wheel-made goblet [Fig. 15:1], its broken pieces scattered in opposite ends of the shaft. Post-Meroitic burials from the Dongola Reach are not known to contain such vessels, the nearest parallels coming from Meroitic and Post-Meroitic Lower Nubia (e.g. Edwards 1998: 72). The shaft assemblage also included the shoulders and body of a bottle of much worse quality than the same kind of vessels from the tomb chambers [Fig. 15:2].

## REFERENCES

- Abdel Rahman, Ali M., Kabashy, H.  
 1999 Two seasons in the Fourth Cataract region. Preliminary results, *Sudan & Nubia* 3, 60-70
- Adams, W.Y.  
 1986 *Ceramic Industries of Medieval Nubia*, Lexington
- Edwards, D.N.  
 1998 The excavations in the Trench 10/14 area, *Sudan & Nubia* 2, 65-73
- El-Tayeb, M.  
 1994 Excavations at El-Ghaddar – Old Dongola, [in:] C. Bonnet (ed.), *Études Nubiens. Conférence de Genève. Actes du VII<sup>e</sup> Congrès international l'études nubiennes 3-8 septembre 1990*, Genève II, 65-82  
 2002 *Genesis of the Makurian Culture in the Light of Archaeological Sources* [=CRIPEL Supplement 6], Lille : Université Charles-de-Gaulle, Lille III  
 2005 Early Makuria Research Project. Excavations at el-Zuma. Preliminary Report, *PAM XVI* [=Reports 2004], 389-399
- Godlewski, W.  
 1991 The fortifications of Old Dongola. Report on the 1990 season, *ANM* 5, 103-123
- Liverani Vincentelli, I.  
 1997 Two fields season in the Napata region, *Kush* XVII, 162-185
- Klimaszewska-Drabot, E.  
 Forthcoming Pottery assemblage from Tanqasi cemetery [in:] W. Godlewski, A. Lajtar (eds), *Between the Cataracts, Proceedings of the 11th Conference of Nubian Studies, Warsaw University, 27 August - 2 September 2006, Part Two: Session Papers* [=PAM Supplement Series, vol. 2.2], Warsaw University Publishers, Warsaw, in press
- Kołosowska, E., El-Tayeb, M.  
 2003 Pottery from the Fourth Cataract region, *GAMAR* 2, 117-126
- Philips, J., El-Tayeb, M.  
 2003 The pottery assemblage from the Hammur Abbasiya tumulus field (SDRS Hammur 2) [in:] B. Żurawski, *Survey and Excavations between Old Dongola and Ez-Zuma*, Southern Dongola Reach Survey 1, Nubia II, Warsaw, 458-462
- Pluskota, K.  
 1991 Dongola. A pottery production centre from the Early Christian period (in:) W. Godlewski (ed.), *Coptic and Nubian Pottery. Part II. International workshop, Nieborów, 29-31 August 1988* [=National Museum in Warsaw Occasional Paper], Warsaw, 34-56  
 2005b Pottery and lime kilns in the Fourth Cataract GAME concession, *GAMAR* 4, 125-132  
 2005a Amphorae of Old Dongola: Evolution of local production (exploration of kiln R1 F), *GAMAR* 3, 227-232
- Shinnie, P.L.  
 1954 Excavations at Tanqasi, 1953, *Kush* II, 66-85